

TYPICAL ELEVATION WITH FASTENER SPACING

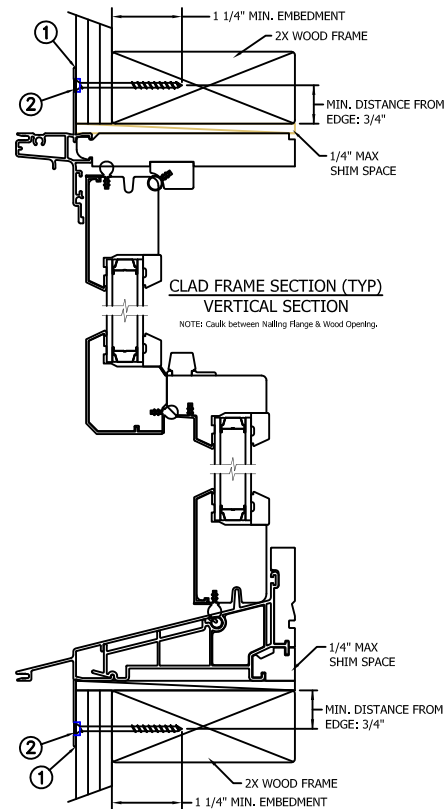

NAIL FIN INSTALLATION

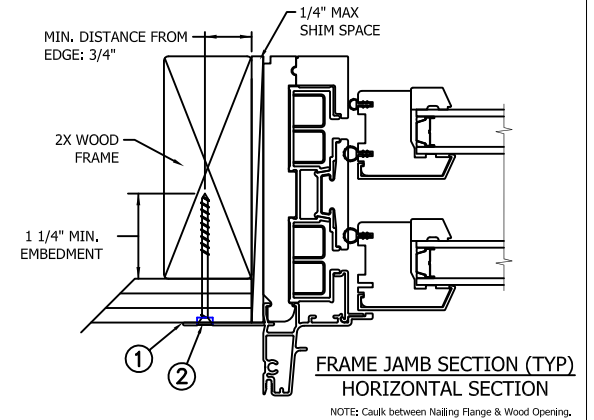

Max Frame	DP Rating	Impact
45 3/8" x 80"	+/-50	NO

Installed Fastener Schedule:

1. Seal flange/frame to substrate.
2. All windows: install corrosion resistant #8 fasteners no more than 4" from each corner and 8" o.c. through the nail fins on all sides of the window. Fasteners must be long enough to penetrate at least 1 1/4" into framing members.

General Notes:

1. The product shown herein is designed, tested and manufactured to comply with the wind load criteria of the adopted International Building Code (IBC), the International Residential Code (IRC), the Florida Building Code (FBC) and the industry standard requirement for the stated conditions.
2. Buck, framing and masonry by others and is responsibility of architect or engineer of record.
3. All glazing shall conform to ASTM E1300.
4. At minimum, glazing shall be double strength annealed insulating glass.

This schedule addresses only the fasteners required to anchor the window to achieve the rated design pressure up to the size limitations noted. It is not intended as a guide to the installation process and does not address the sealing consideration that may arise in different wall conditions. For the complete installation procedure, see the instructions packaged with the door or go to www.jeld-wen.com/resources/installation.

DISCLAIMER:

This drawing and its contents are confidential and are not to be reproduced or copied in whole or in part or used or disclosed to others except as authorized by JELD-WEN Inc.

PROJECT ENGINEER: --	DATE: 01/19/2015
DRAWN BY: D. Vezo	SCALE: NTS
CHECKED BY: J. Jones	TITLE:
APPROVED BY: D. Stokes	
PART/PROJECT No.:	
D012039	
IDENTIFIER No. N/A	PLANT NAME AND LOCATION: Rantoul, IL

JELD-WEN 3737 Lakeport Blvd
Klamath Falls, OR. 97601
Phone: (541) 882-3451

Siteline Clad Double Hung Window

CAD DWG. No.:	REV:	SHEET
---------------	------	-------